

SMART Slate WS200

User's Guide

Extraordinary made simple™



Product Registration

If you register your SMART product, we'll notify you of new features and software upgrades.

Register online at www.smarttech.com/registration.

Keep the following information available in case you need to contact SMART Technical Support.

Serial Number: _____

Date of Purchase: _____

FCC Warning

This equipment has been tested and found to comply with the limits for a Class B digital device, pursuant to Part 15 of the FCC Rules. These limits are designed to provide reasonable protection against harmful interference in a residential installation. This equipment generates, uses and can radiate radio frequency energy and, if not installed and used in accordance with the instructions, may cause harmful interference to radio communications. However, there is no guarantee that interference will not occur in a particular installation. If this equipment does cause harmful interference to radio or television reception, which can be determined by turning the equipment off and on, the user is encouraged to try to correct the interference by one of the following measures:

- Reorient or relocate the receiving antenna.
- Increase the separation between the equipment and receiver.
- Connect the equipment into an outlet on a circuit different from that to which the receiver is connected.
- Consult the dealer or an experienced radio/TV technician for help.

This device complies with Part 15 of the FCC Rules. Operation is subject to the following two conditions: (1) This device may not cause harmful interference, and (2) this device must accept any interference received, including interference that may cause undesired operation.

FCC Caution

Any changes or modifications not expressly approved by the party responsible for compliance could void the user's authority to operate this equipment.

FCC Radiation Exposure

This equipment complies with FCC radiation exposure limits set forth for an uncontrolled environment. End users must follow the specific operating instructions for satisfying RF exposure compliance. This transmitter must not be co-located or operating in conjunction with any other antenna or transmitter.

IC Statement

Operation is subject to the following two conditions: 1) this device may not cause interference and 2) this device must accept any interference, including interference that may cause undesired operation of the device.

Trademark Notice

The SMART logo, SMART Board and smarttech are trademarks or registered trademarks of SMART Technologies ULC in the U.S. and/or other countries. The Bluetooth word mark is owned by the Bluetooth SIG, Inc. and any use of such marks by SMART Technologies ULC is under license. All other third-party product and company names may be trademarks of their respective owners.

Copyright Notice

©2009 SMART Technologies ULC. All rights reserved. No part of this publication may be reproduced, transmitted, transcribed, stored in a retrieval system or translated into any language in any form by any means without the prior written consent of SMART Technologies ULC. Information in this manual is subject to change without notice and does not represent a commitment on the part of SMART.

Patent No. US6320597; US6326954; US6741267; US7151533; US7499033; CA225230. Other patents pending.

11/2009

Important Information

WARNINGS

- Do not puncture, crush, heat or disassemble the battery, expose it to fire or any liquid, short its terminals, or abuse the battery in any other way because this can cause the battery to explode or ignite, and can cause personal injury or a fire.
- If the battery leaks, ensure that you do not get battery fluid in your eye. If you do, immediately rinse the affected eye with water and seek medical attention.
- Do not install the battery backwards or reverse the polarity. Do not install other battery types in the SMART Slate WS200 wireless slate. Both of these actions can cause damage to the slate and can cause personal injury or a fire.
- If the SMART Slate WS200 becomes excessively warm or emits an unusual smell while the battery is charging, immediately disconnect the charging cable from the slate and turn off the slate.
- When you dispose of the lithium ion battery, cover the terminals with adhesive tape to prevent possible contact with conductive material. As an additional precaution, do not transport the battery with conductive material. If the battery comes into contact with conductive material, the battery can short, and cause personal injury or a fire.
- When regulations require that wireless devices are turned off, for example, on commercial aircraft, ensure that the SMART Slate WS200 is turned off and can not be turned on accidentally.
- Do not use the SMART Slate WS200 in a facility control system or any other environment that requires extremely high reliability, or where the use of a wireless device can cause interference; the slate can interfere with or cause other electronic devices to malfunction, or other wireless devices can interfere with or cause the slate to malfunction. Where use is prohibited, turn off the slate to prevent the possibility of it interfering with or causing other electronic devices to malfunction. SMART does not accept any liability for direct or consequential damages.

Contents

1	Overview	1
	About Your SMART Slate WS200	1
	Tethered Pen	2
	USB Charging Cable	2
	USB Wireless Adapter.....	3
2	Setting Up Your SMART Slate	5
	Attaching the Pen Tether	6
	Removing the Battery-Insulating Film	7
	Charging Your Slate	8
	Installing Your USB Wireless Adapter.....	8
	Creating a Wireless Connection with Your Computer	9
	Installing SMART Product Drivers.....	10
	Installing a Paper Underlay	10
	Connecting Your SMART Slate With Built-In or Third-Party Wireless Adapters	12
3	Using Your Slate	13
	About the Workspace	13
	Turning On and Connecting the Slate	14
	Using the Pen.....	14
	Using the Slate Buttons.....	15
	Using the Tools on the Icon Strip	16
	Checking the Battery Charge	16
	Locking Your Slate	16
	Storing the Pen	17
	Storing the USB Wireless Adapter	17

	Locking Up Your Slate	17
4	Customizing Your Slate.....	19
	The SMART Notebook Control Panel.....	19
	Changing the Functions of the Slate and Pen Buttons	20
	Customizing the Pen and the Eraser.....	21
	Changing the Tip Feel.....	21
	Changing the Icon Strip.....	22
	Customizing the Appearance of the Paper Underlay	25
	Changing How the Slate Maps to Your Display	26
	Changing Mouse and Gesture Settings	27
5	Troubleshooting	29
	Determining Whether Your Slate Is Connected to Your Computer.....	29
	Re-establishing the Wireless Connection.....	30
	Deleting a Wireless Connection and Creating a New One.....	30
	Understanding Your Slate's LED States	31
	Troubleshooting Pen Issues.....	32
A	Hardware Environmental Compliance.....	33
	Waste Electrical and Electronic Equipment Regulations (WEEE Directive) .	33
	Restriction of Certain Hazardous Substances (RoHS Directive)	33
	Batteries.....	34
	Packaging	34
	Covered Electronics Devices.....	34
	China's Electronic Information Products Regulations.....	34
	U.S. Consumer Product Safety Improvement Act	34
B	Customer Support	35
	Online Information and Support.....	35
	Training.....	35
	Technical Support.....	35

Shipping and Repair Status	35
General Inquiries	36
Warranty	36
Registration.....	36

Chapter 1

Overview

About Your SMART Slate WS200

The SMART Slate connects wirelessly to your computer and a SMART Board™ interactive whiteboard, allowing you to write notes, use programs and perform normal computer operations from a distance of up to 32' (10 m).

- You can customize a printed underlay with an icon strip of the tools and links that you use most often.
- You can change the function of the three buttons on the slate.
- You can use the pen storage compartment to store the pen when you aren't using it.
- You can use the storage compartment on the back of the slate to store the USB wireless adapter when you aren't using the adapter.
- You can use the Kensington® security slot to lock the slate when you aren't using it.

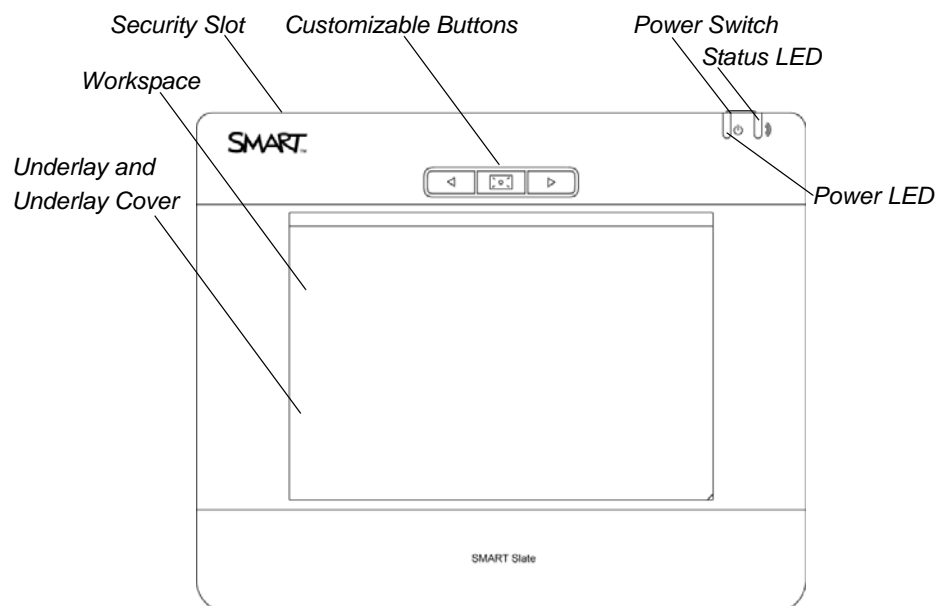

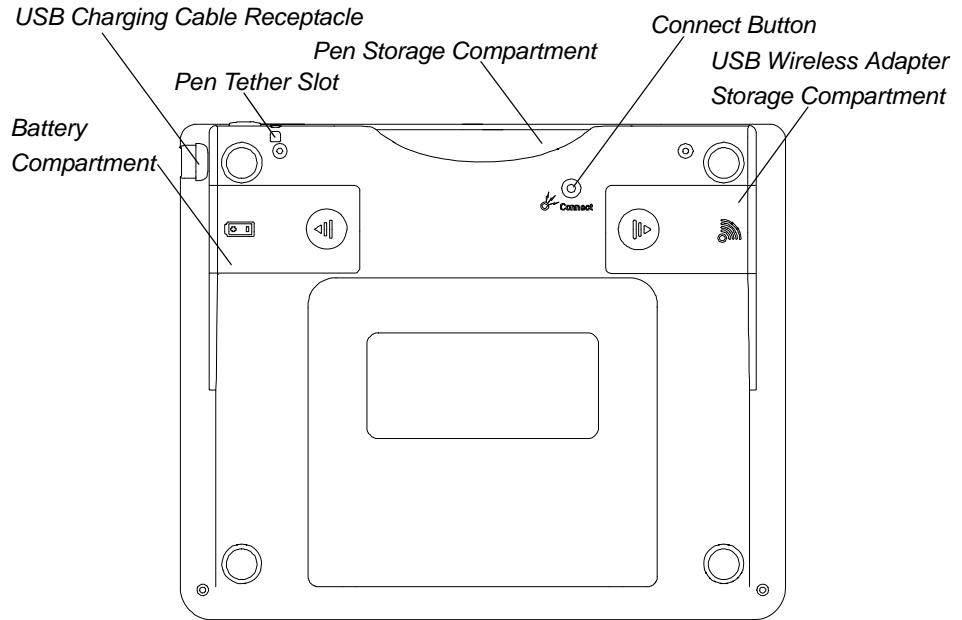

Tethered Pen

The pen controls the pointer on your display. Move the pen above the workspace of the slate to move the pointer. When you touch the pen to the slate your computer registers the point of contact as a left click. Touch the pen to the slate to write notes and use computer programs. The pen has a rocker switch and an eraser that you can customize. The tether attaches the pen to the slate so you don't misplace the pen.

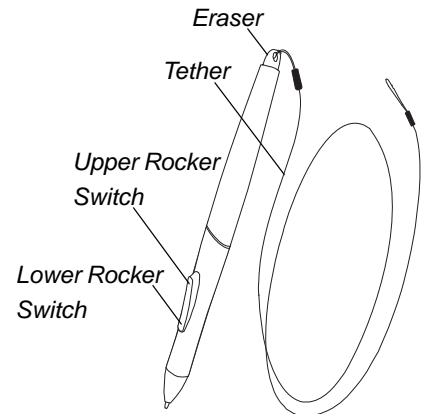

USB Charging Cable

You can charge your slate by connecting it to your computer with the USB charging cable. Your slate comes with an installed lithium ion battery. It takes six hours to fully charge the battery, which lasts for more than 24 hours.

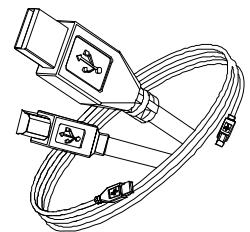

USB Wireless Adapter

You can order your slate with the USB wireless adapter and installation CD. The USB adapter uses Bluetooth® technology to create a wireless connection between your slate and your computer.

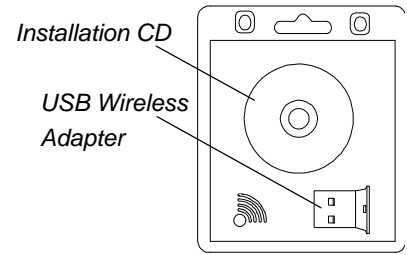

Chapter 2

Setting Up Your SMART Slate

There are a few things you need to do before you use your slate. This chapter describes the following set up tasks:

- Attaching the pen tether (page 6)
- Removing the battery-insulating film (page 7)
- Charging the slate (page 8)
- Installing the USB wireless adapter (page 8)
- Creating a wireless connection to your computer (page 9)
- Installing SMART Product Drivers on your computer (page 10)
- Installing a paper underlay (page 10)
- Connecting your slate using built-in or third-party wireless adapters (page 12)

Attaching the Pen Tether

The tether connects the pen to the slate so you don't misplace the pen.

To attach the tether to the pen

1. Thread one tether loop through the hole at the end of the pen.
2. Feed the other tether loop through the first loop as shown in the diagram below, and then pull the tether so the first loop is snug.

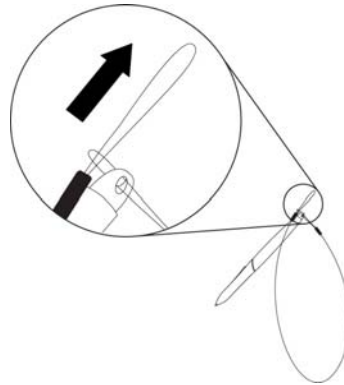

To attach the tether to the slate

1. Place the other tether loop through the tether slot in the slate.
2. Feed the pen, with the tether attached, through the loop as shown in the diagram below, and then pull the tether so the loop is snug.

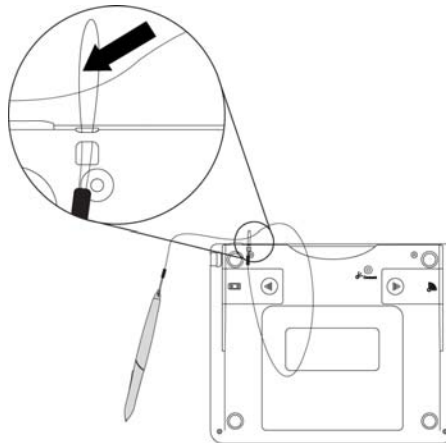

Removing the Battery-Insulating Film

Your slate comes with a lithium ion battery installed. There is a small sheet of insulating film in the battery compartment that prevents battery power discharge. Remove the insulating film before you charge and use your slate.

To remove the insulating film

1. Remove the battery compartment cover, and then remove the battery.

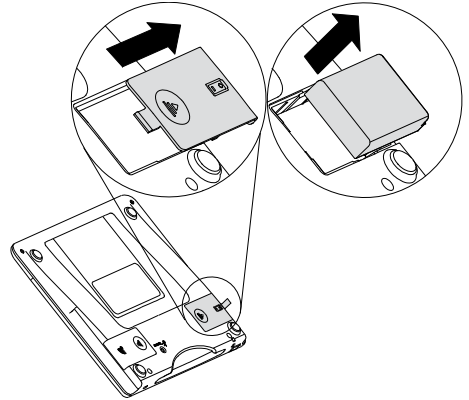

2. Remove the battery insulating film from the battery compartment.

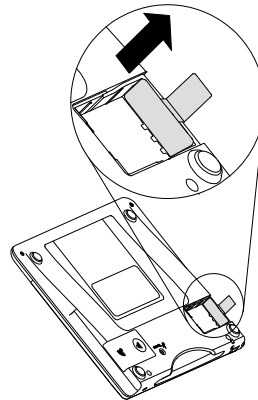

3. Replace the battery in the battery compartment, and then replace the battery compartment cover.

Charging Your Slate

The slate's lithium ion battery powers the slate so your movement isn't restricted by a power cable. You can charge the slate by connecting it to your computer with the USB charging cable. It takes six hours to charge the slate. A fully charged slate lasts for more than 24 hours of continuous use.

WARNING

If the SMART Slate WS200 becomes excessively warm or emits an unusual smell while the battery is charging, immediately disconnect the charging cable from the slate and turn off the slate.

To charge your slate

1. Turn on your computer.
2. Connect the USB charging cable to your computer.
3. Connect the USB mini connector of the charging cable to your slate.

The slate starts to charge and the power LED glows green.

Installing Your USB Wireless Adapter

Your slate comes with a USB wireless adapter and an adapter installation CD. The USB adapter uses Bluetooth technology to create a wireless connection between your slate and your computer.

To install the USB wireless adapter

1. Insert the USB wireless adapter installation CD into your computer's CD drive, and then follow the on-screen instructions.
 2. Connect the USB wireless adapter to your computer's USB receptacle.
-

Creating a Wireless Connection with Your Computer

After you install the USB wireless adapter, you can create a wireless connection between your slate and your computer.

To create a wireless connection

1. Slide the power switch to the on position **ⓘ**.
2. Press the **Connect** button on the back of the slate.

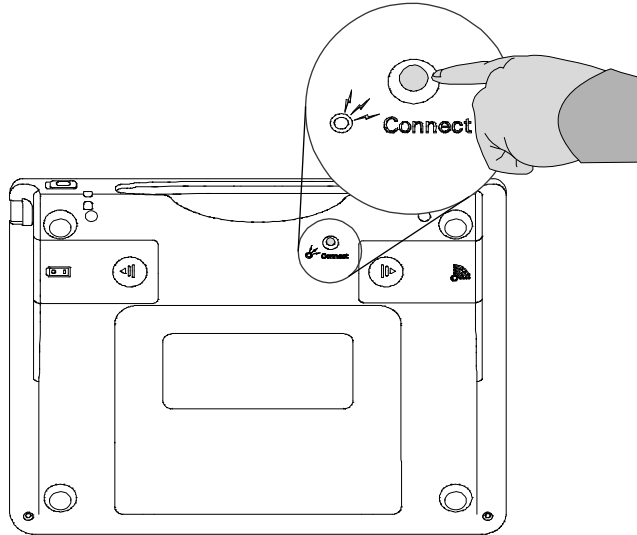

The status LED on the slate blinks green.

3. Double-press the Bluetooth icon in your computer's notification area.

The *Bluetooth Settings* window appears.

4. Press **New Connection**.

The *Add New Connection Wizard* appears.

5. Select the **Express Mode** check box, and then click **Next**.
6. Click **SMART Slate WS200** in the list of devices, click **Next**, and then complete the steps in the connection wizard.

i NOTE

If a dialog box appears asking you to enter a pass key, type **0000** in the pass key box, and then click **Next**.

When your slate is wirelessly connected to your computer, the status LED on the slate stops blinking amber and glows pale green.

Installing SMART Product Drivers

Your SMART Slate WS200 comes with a SMART Product Drivers CD. SMART Product Drivers enable your computer to connect to the slate.

To install SMART Product Drivers

Insert the SMART Product Drivers CD into your computer's CD drive, and then follow the on-screen instructions.

To update SMART Product Drivers

1. Press the SMART Board icon in your computers's notification area, and then select **Check for Updates**.

The *SMART Product Update* window appears.

2. If a driver update is available press **Update**.



NOTE

You can also download driver updates from the [SMART Support website](#).

Installing a Paper Underlay

An underlay is a sheet of paper with an icon strip that you place under the underlay cover on the workspace. You can customize the underlay and icon strip, and then print the underlay (see page 22). To use a tool, touch the pen to the tool's icon on the icon strip.

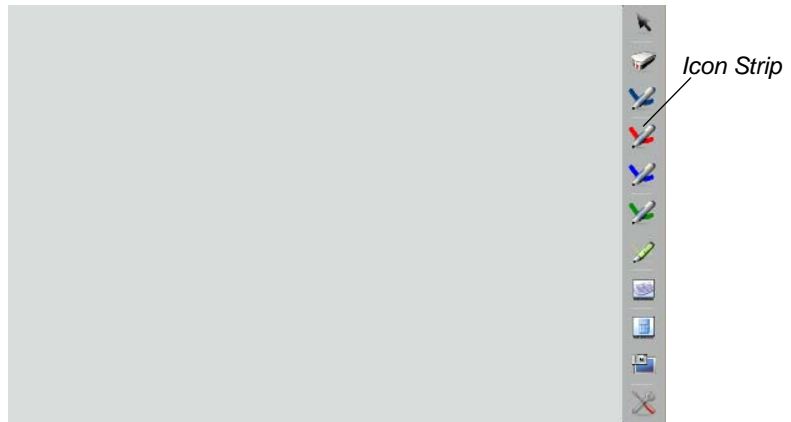

To print an underlay

1. Press the SMART Board icon  in your computer's notification area, and then select **Control Panel**.
2. Press **SMART Hardware Settings** and if you have more than one SMART product connected, press **SMART Slate**.
3. Select **Set Up Underlay and Icon Strip** from the first drop-down list.
4. Select an existing underlay from the color scheme drop-down list.
5. Press **Print**.

The *Print* dialog box appears.

6. In your printer preferences, select landscape orientation, and then print the underlay.

 NOTE

If you print the underlay in portrait orientation, your printer could scale the underlay to fit the page, making the underlay smaller than the slate workspace.

To install the underlay

1. Trim the excess paper from the edges of the underlay.
2. Lift the underlay cover from the lower right corner with your fingers.
3. Slide the underlay beneath the underlay cover.

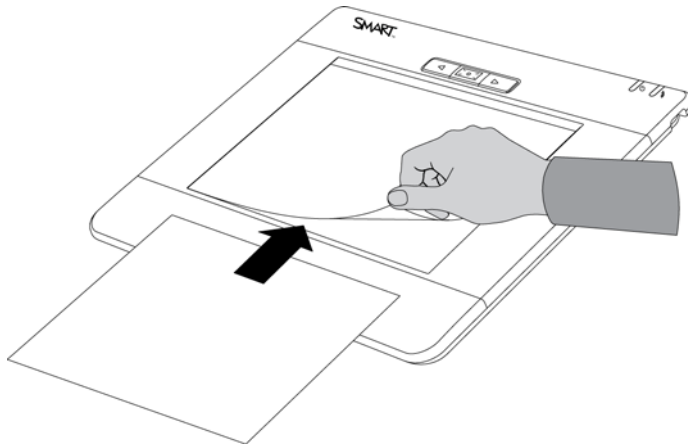

4. Lower the underlay cover.

Connecting Your SMART Slate With Built-In or Third-Party Wireless Adapters

If you're unable to order a SMART USB wireless adapter, you can use your computer's built-in Bluetooth adapter or buy a third-party USB wireless adapter.



IMPORTANT

Ensure your wireless adapter has Bluetooth wireless technology version 2.1 with EDR.

Refer to your computer or your third-party wireless adapter's product documentation for installation and connection information.

Chapter 3

Using Your Slate

This chapter describes the following topics for using your slate:

- Turning on and connecting the slate (page 14)
- Using the pen (page 14)
- Using the slate buttons (page 15)
- Using the tools on the icon strip (page 16)
- Checking the battery charge (page 16)
- Locking your slate (page 17)
- Storing the USB wireless adapter (page 17)
- Locking up your slate (page 17)

About the Workspace

The slate's workspace represents the screen of your display. If you move the pen to the top right corner of the workspace, the pointer moves to the top right corner of your display. If you move the pen to the lower right corner of the slate, the pointer moves to the lower right corner of your display. If you have more than one display, you can change the settings so the slate's workspace represents two displays (see page 26). The workspace is the only area on the slate that detects the pen.

The strip on the right side of the workspace is for common tools. When you touch the pen to an icon on this strip, the pointer turns into the tool you selected. You can change the tools that appear in the icon strip (see page 20).

Turning On and Connecting the Slate

After you create a wireless connection between your slate and your computer (see page 9), your slate automatically connects with your computer when you turn on the slate.

IMPORTANT

Do not press the **Connect** button on the back of your SMART Slate if you already created a wireless connection. If you do, delete the SMART Slate WS200 connection in the *Bluetooth Settings* window, and then create a new connection (see page 30).

NOTE

If you connect your slate to more than one computer, the slate searches for the last computer it was connected to when you turn the slate on. If you want to connect the slate to a computer other than the one you last used with the slate, delete the SMART Slate WS200 connection in the *Bluetooth Settings* window, and then create a new connection (see page 30).

To turn on the slate

Slide the power switch to the on position .

The power LED glows green and the status LED glows pale green, indicating that the slate is on and connected to your computer.

Using the Pen

The pen controls the pointer on your display. The pen has a rocker switch, with an upper and lower position, and an eraser.

NOTES

- You can change the functions of the rocker switch and the eraser (see page 20).
- You can perform common tasks, such as writing and erasing digital ink, by selecting a tool from the icon strip (see page 16).

To move the pointer on your display

Move the pen a few millimeters above the workspace.

NOTE

You can also move the pointer by touching and sliding the pen on the workspace. See page 27 for information on disabling the hover setting.

To perform a left click

Touch the pen to the workspace.

To perform a right click Press the upper rocker switch, and then touch the pen to the workspace.

To write in digital ink Press the lower rocker switch as you touch and slide the pen on the workspace.

If the application you're writing on isn't Ink Aware (it isn't integrated with SMART Notebook software), anything you write or draw appears on a transparent layer over the current application. You can close the transparent layer by clicking the **Close** button in the upper right corner of the screen.

To erase digital ink Flip the pen upside down and touch and slide the pen on the workspace.

Using the Slate Buttons

The slate has three buttons above the workspace. You can change the functions of these buttons so that the tools you use most are easily accessible (see page 20).

To open SMART Notebook software Press the center slate button.

To move back one page Press the left arrow slate button to move back one page in SMART Notebook software.

To move forward one page Press the right arrow slate button to move forward one page in SMART Notebook software.

Using the Tools on the Icon Strip

Touch the pen to a tool on the underlay icon strip. You can add or remove tools, Web links and application links in the SMART control panel (see page 20).

To use a tool on the icon strip

1. Touch the pen to the tool on the icon strip that you want to use.

The pointer changes to the tool you select.

NOTE

The area along the right side of the slate workspace is for selecting icon strip tools. If you don't have an underlay and you touch this area with the pen, you select a tool.

2. Touch the pen to the workspace.

Checking the Battery Charge

You can check the battery charge in the SMART Notebook control panel.

To check the battery charge

1. Press the SMART Board icon  in your computer's notification area, and then select **Control Panel**.

The SMART Notebook control panel appears.

2. Press **SMART Hardware Settings**.

NOTE

If you have more than one SMART product connected to your computer, press **SMART Slate** in the list of devices.

The battery charge status appears in the upper right corner.

Locking Your Slate

You can lock the SMART Slate and stop it from interacting with your computer and display.

To lock the slate

Press the SMART Board icon  in your computer's notification area, and then select **Other SMART Tools > Lock SMART Slates Only**.

The slate is unable to interact with your computer and the *SMART Slates Locked* window appears.

To unlock the slate Press the **Click to unlock** icon  in the *SMART Slates Locked* window.

OR

Press the SMART Board icon  in your computer's notification area, and then select **Other SMART Tools > Unlock SMART Slates**.

Storing the Pen

You can store the pen in the storage compartment when you aren't using the pen.

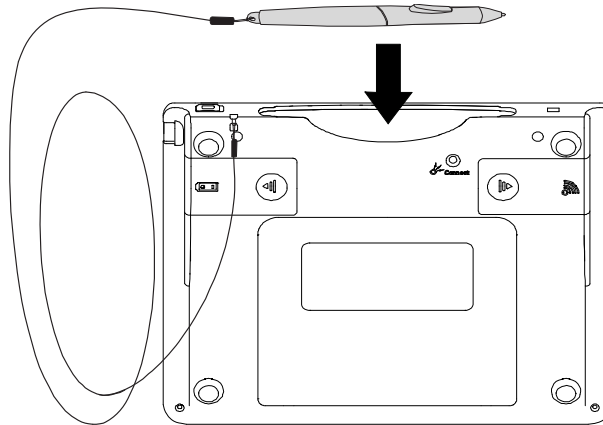

Storing the USB Wireless Adapter

You can store the USB wireless adapter in the storage compartment on the back of the slate. A foam pad in the storage compartment prevents the USB wireless adapter from rattling.

Locking Up Your Slate

Your slate has a Kensington security slot, which allows you to use a lock to secure your slate from theft.

Chapter 4

Customizing Your Slate

This chapter describes tasks for customizing your slate:

- Changing the functions of the slate and pen buttons (page 20)
- Customizing the pen and the eraser (page 21)
- Changing the tip feel (page 21)
- Changing the icon strip (page 22)
- Customizing the appearance of the paper underlay (page 25)
- Changing how the slate maps to your display (page 26)
- Changing mouse and gesture settings (page 27)

The SMART Notebook Control Panel

You can customize many of your slate's features from the SMART Notebook control panel. You can change the functions of buttons, change digital ink styles, create a custom icon strip on a paper underlay and change other features.

To open the SMART Notebook control panel

1. Press the SMART Board icon  in your computer's notification area, and then select **Control Panel**.

The SMART Notebook control panel appears.

2. Press **SMART Hardware Settings**.

NOTE

If you have more than one SMART product connected to your computer, press **SMART Slate** in the list of devices.

Changing the Functions of the Slate and Pen Buttons

You can change the functions of the slate buttons, the pen rocker switch and the pen eraser.

To change the functions of the slate and pen buttons

1. In the SMART Notebook control panel, use the drop-down lists to select a function for the button that you want to change. You can select the following options for the slate buttons:

Function	Description
Print Page	Print the current SMART Notebook page.
Next Page	Display the next SMART Notebook page.
Previous Page	Display the previous SMART Notebook page.
Clear Screen	Clear the current SMART Notebook page.
Right-click	Perform a right click.
Middle-click	Perform a middle click.
Keyboard	Starts the on-screen keyboard.
Floating Tools	Starts the Floating Tools.
Notebook Software	Starts SMART Notebook software.
Screen Capture	Starts the screen capture tools.
Disabled	Assign no function to the button.

For the pen buttons, you can select any of the functions listed above, or these pen-specific functions:

Function	Description
Eraser	Erase digital ink with the pen.
Pen	Write digital ink with the pen.

2. Press **OK** to save your changes.

Customizing the Pen and the Eraser

You can change the line transparency, color, line thickness and fill effect as well as the eraser thickness.

To change the line transparency

1. In the SMART Notebook control panel, select **Pen and Button Settings** from the first drop-down list.
2. Select **Pen** from one of the pen drop-down lists, and then press **Customize**.
The *Properties* dialog box appears.
3. Use the Object transparency slider to change the line transparency.
4. Press **Save Tool Properties** to save your changes.

To change the ink line style

1. In the SMART Notebook control panel, select **Pen and Button Settings** from the first drop-down list.
2. Select **Pen** from one of the pen drop-down lists, and then press **Customize**.
The *Properties* dialog box appears.
3. Press **Line Style**.
4. Select a color, a thickness and any other line styles.
5. Press **Save Tool Properties** to save your changes.

To change the eraser thickness

1. In the SMART Notebook control panel, select **Pen and Button Settings** from the first drop-down list.
 2. Select **Eraser** from one of the pen drop-down lists, and then press **Customize**.
 3. Press an eraser thickness and then press **OK** to save your changes.
-

Changing the Tip Feel

The tip feel is the amount of pressure you need to apply for the pen to register a contact point with the slate. You can increase or decrease the pen's touch sensitivity with the Tip Feel slider.

To change the pen tip feel

In the SMART Notebook control panel, move the **Tip Feel** slider to change the tip feel, and then press **OK** to save your changes.

Changing the Icon Strip

You can add tools or links to the icon strip on the underlay, change the order icons and remove them.

To add a tool to the icon strip













1. In the SMART Notebook control panel, select **Set Up Underlay and Icon Strip** from the first drop-down list.
2. Press **Configure Icon Strip**.
3. Select the tool you want to add to the icon strip in the Available Tools column, and then press **Add**.

The tool you select appears in the Current Toolbar column.

NOTE











You can have up to 11 tools on the icon strip. If you already have 11 tools on the icon strip, you must remove a tool before you can add another one.

You can add from the following tools from the **Launch** tab:







Tool	Function
 Notebook	Starts SMART Notebook software.
 Recorder	Starts SMART Recorder.
 Video Player	Starts SMART Video Player.
 Keyboard	Starts the SMART Keyboard.
 Floating Tools	Starts Floating Tools.
 Screen Spotlight	Starts the Spotlight tool, which draws attention to an area of your display.
 Screen Shade	Starts the Screen Shade, which covers the information on your display allowing you to reveal it gradually.
 Pointer	Inserts a pointer on your display that draws attention to information on your display.
 Calculator	Starts the Calculator.
 Magnifier	Starts the Magnifier, which allows you to magnify an area of the screen.
 Control Panel	Starts the SMART Notebook control panel.
 Help	Launches SMART Notebook Help.
 Lock Airliners	Locks slates from interacting with your computer.

Tool	Function
 Start/Stop Senteo Quiz	Starts or stops a SMART Response (formerly Senteo) quiz.

You can add these tools from the **General** tab:

Tool	Function
 Right-click	Your next pen touch is a right click.
 Middle-click	Your next pen touch is a middle click.
 Print...	Opens the <i>Print</i> dialog box.
 Screen Capture Toolbar	Starts the Screen Capture toolbar.
 Full Screen Capture	Takes a screen capture of the entire screen.
 Area Capture	Allows you to touch the pen on the workspace to take a screen capture of an area.
 Undo	Reverses the previous action.
 Help	Launches Help for the active window.
 Page Up	Displays the previous SMART Notebook page.
 Page Down	Displays the next SMART Notebook page.

You can add these tools from the **Tools** tab:

Tool	Function
 Select	Select text and objects.
 Pen	Write in digital ink.
 Creative Pen	Draw a line of rainbow colors, smiley faces, stars and more.
 Highlighter	Highlight in digital ink.
 Line	Draw a line.
 Shape	Create a variety of shapes.
 Eraser	Erase digital ink.

To remove a tool from the icon strip

1. In the SMART Notebook control panel, select **Set Up Underlay and Icon Strip** from the first drop-down list.
2. Press **Configure Icon Strip**.
3. Select the tool you want to remove from the icon strip in the Current Toolbar column, and then press **Remove**.

The tool you select appears in the Available Tools column.

To add a link to the icon strip

1. In the Control Panel, select **Set Up Underlay and Icon Strip** from the first drop-down list.
2. Press **Configure Icon Strip**.
3. Press **Link to Website**.

The *Link to Website...* dialog box appears.

4. Type the Web address you want to link to, and then press **OK**.

The link appears in the Current Toolbar column.

To add a shortcut to an application or folder

1. In the SMART Notebook control panel, select **Set Up Underlay and Icon Strip** from the first drop-down list.
2. Press **Configure Icon Strip**.
3. Press **Browse**.

The *Open* dialog box appears.

4. Browse to and select the application or folder that you want to create a shortcut to, and then press **Open**.

The shortcut appears on the icon strip.

To arrange the tools on the icon strip

1. In the SMART Notebook control panel, select **Set Up Underlay and Icon Strip** from the first drop-down list.
 2. Press **Configure Icon Strip**.
 3. Select the tool that you want to move, and then press **Move Up** or **Move Down** to change its position on the icon strip.
-

To change the position of the icon strip

1. In the SMART Notebook control panel, select **Set Up Underlay and Icon Strip** from the first drop-down list.
2. Press **Configure Icon Strip**.

3. In the Position Icon Strip drop-down list, select where you want the icon strip to appear.

Customizing the Appearance of the Paper Underlay

You can customize the appearance and layout of the underlay.

To add lines to the underlay background

1. In the SMART Notebook control panel, select **Set Up Underlay and Icon Strip** from the first drop-down list.
2. Press **Customize Underlay**.
3. Select the **Horizontal Lines** check box to add horizontal lines to the background.
4. Select the **Vertical Lines** check box to add vertical lines to the background.

To change the underlay color

1. In the SMART Notebook control panel, select **Set Up Underlay and Icon Strip** from the first drop-down list.
2. Press **Customize Underlay**.
3. Select the **Center Color** check box to change the center color.
OR
Select the **Icon Strip Color** check box to change the icon strip color.
The *Select Color* dialog box appears.
4. Select one of the color palettes from the basic colors.
OR
Move the color slider and the color crosshair to create a custom color, press **Add to Custom Colors**, and then select the color.

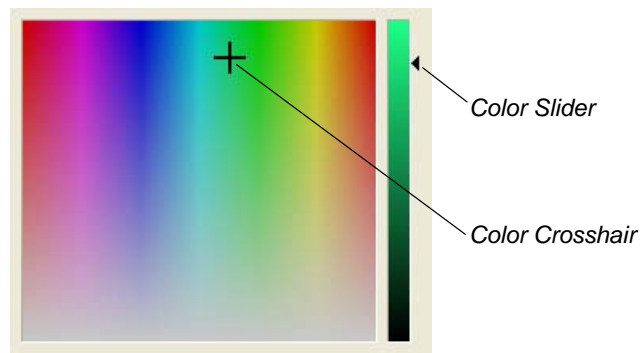

5. Press **OK**.
The color of the center of the underlay changes.

To insert an image onto the underlay

1. In the SMART Notebook control panel, select **Set Up Underlay and Icon Strip** from the first drop-down list.
2. Press **Customize Underlay**.
3. Under Image Properties, press **Add**.
The *Open* dialog box appears.
4. Browse to and select the image file that you want to insert onto the underlay.
5. Press **Open**.
The image appears in the center of the underlay.
6. Move the **Transparency** slider to adjust the image transparency.
7. Select the image position (either centered or stretched) from the *Position* drop-down list.
8. Press **OK**.

Changing How the Slate Maps to Your Display

By default, your slate's workspace represents one display. If you have more than one display, you can choose the display you want the workspace to represent, or you can have the workspace represent two displays.

To change how your slate maps to your display

1. In the SMART Notebook control panel, select **Orientation/Alignment Settings** from the first drop-down list.
2. From the second drop-down list, select one of the following settings:

Setting	Function
Display 1	The slate workspace represents display 1.
Display 2	The slate workspace represents display 2.
Entire Surface	The slate workspace represents both displays.



3. Press **OK** to save your changes.

Changing Mouse and Gesture Settings

You can change the mouse and gesture settings for your slate.

To change the mouse and gesture settings for your slate

1. In the SMART Notebook control panel, select **Mouse and Gesture Settings** from the first drop-down list. You can change the following settings:

Setting	Function
Double-Click Zone	You can increase or decrease the zone that registers as a double click. For a small double-click zone, ensure that the second pen touch is in the same spot on the workspace as the first pen touch. If you find it difficult to double click, increase the double-click zone. Double-click the Test Area folder  . If the folder opens  , then the double-click zone is adequate.
Enable Mouse Assist	Mouse Assist helps move your pointer to clickable objects on your display, such as the Close button and scroll bars.
Enable Hover	The hover setting is the default pen setting and allows you to move the pointer on your display without touching the pen to the workspace. You can disable the hover setting by clearing the selection of the Enable Hover check box. To move the pointer when the hover setting is disabled, touch the pen to the slate and then slide the pen on the workspace.
Enable Single-Touch Gestures	You can use single-touch gestures, such as right click (when you touch and hold the pen to the workspace, you perform a right click).
Enable Pop-Up Messages	Pop-up messages appear when you select the right-click tool or when you clear your digital ink.

2. Press **OK** to save your changes.

Chapter 5

Troubleshooting

This chapter describes the following troubleshooting topics:

- Determining whether your slate is connected to your computer (page 29)
- Re-establishing the wireless connection (page 30)
- Deleting a wireless connection and creating a new one (page 30)
- Understanding your slate's LED states (page 31)
- Troubleshooting pen issues (page 32)

Determining Whether Your Slate Is Connected to Your Computer

If your computer isn't responding to your SMART Slate, check whether your slate is connected to the computer.

To determine whether your slate is connected

Double-press the Bluetooth icon  in your computer's notification area.

The *Bluetooth Settings* window appears.

If your slate is connected to your computer, you see this SMART Slate WS200 icon:





If your slate isn't connected to your computer, you see this SMART Slate WS200 icon:



OR

You can determine whether your slate is connected by the color of the Bluetooth icon. The following table describes what the different colors of the Bluetooth icon mean:

Bluetooth Icon	Description
Green 	Your computer detects the USB wireless adapter, and your slate is connected to your computer.
White 	Your computer detects the USB wireless adapter, but your slate isn't connected to your computer.
Red 	Your computer doesn't detect the USB wireless adapter, and your slate isn't connected to your computer.

OR

If your slate is connected to the computer, the SMART Slate appears in the list of devices in the SMART Notebook control panel.

Re-establishing the Wireless Connection

If you restart your computer while your SMART Slate is wirelessly connected, your computer is unable to find the slate and the slate's status LED glows amber.

To re-establish the wireless connection

After your computer has started, press one of the customizable buttons on the slate.

The slate reconnects to the computer and the slate's status LED glows green.

Deleting a Wireless Connection and Creating a New One

If you're unable to re-establish a wireless connection, delete the SMART Slate WS200 connection in the *Bluetooth Settings* window, and then create a new wireless connection.

To delete and create a wireless connection

1. Double-press the Bluetooth icon in your computer's notification area.
The *Bluetooth Settings* window appears.
2. Select the **SMART Slate WS200** icon, and then press **Delete**.
The *Bluetooth Settings* dialog box appears.
3. Press **Yes**.
4. Turn on your slate and press the **Connect** button.
5. Press **New Connection** in the *Bluetooth Settings* window.

The *Add New Connection Wizard* appears.

6. Select the **Express Mode** check box, press **Next** and then complete the steps in the wizard.

i NOTE

If a dialog box appears asking you to enter a pass key, type **0000** in the pass key area, and then press **Next**.

When your slate is wirelessly connected to your slate the status LED on the slate stops flashing and glows green.

Understanding Your Slate's LED States

The following table describes the power LED states:

Power LED State	Description
Green	The battery is fully charged. OR The USB charging cable is connected to your computer and your computer is powering by your slate.
Amber and Blinking Amber	The battery charge is low. Connect the USB charging cable to charge the battery.
Red and Blinking Red	The battery is completely drained. Connect the USB charging cable to charge the battery.
Off	The battery isn't connected. Check the battery compartment and ensure the battery is properly installed. OR The battery insulation film is in the battery compartment. Remove the battery insulating film (see page 7).

The following table describes the status LED states:

Status LED State	Description
Green	Your slate is connected to your computer.
Dark Green	The pen is touching the workspace.
Blinking Green	The slate is searching for your computer to create a wireless connection.
Amber	The slate was once connected to your computer, but the wireless connection is lost.

Troubleshooting Pen Issues

If you encounter issues using the pen, refer to the following table:

Symptom	Solution
<p>You're unable to use the pen to select or write on the interactive pen display.</p> <p>OR</p> <p>When you write or draw with the pen, you see a pointer instead of digital ink.</p>	<p>Soften the pen's tip feel. In the SMART Notebook control panel, select SMART Hardware Settings > Pen and Button Settings, and then adjust the Tip Feel slider.</p>
<p>You're unable to double-click.</p>	<p>Adjust the double-click zone. In the SMART Notebook control panel, select SMART Hardware Settings > Mouse Settings, and then adjust the mouse setting.</p>
<p>You're unable to use the rocker switch.</p>	<ul style="list-style-type: none"> • Ensure that the lower and upper rocker switch buttons are set to the functions that you want. In the SMART Notebook control panel, select SMART Hardware Settings > Pen and Button Settings, and then select the functions from the drop-down lists. • If the issue persists, contact SMART Technical Support.

Appendix A

Hardware Environmental Compliance

SMART Technologies supports global efforts to ensure that electronic equipment is manufactured, sold and disposed of in a safe and environmentally friendly manner.

Waste Electrical and Electronic Equipment Regulations (WEEE Directive)

Waste Electrical and Electronic Equipment regulations apply to all electrical and electronic equipment sold within the European Union.

When you dispose of any electrical or electronic equipment, including SMART Technologies products, we strongly encourage you to properly recycle the electronic product when it has reached the end of its life. If you require further information, please contact your reseller or SMART Technologies for information on which recycling agency to contact.

Restriction of Certain Hazardous Substances (RoHS Directive)

This product meets the requirements of the European Union's Restriction of Certain Hazardous Substances (RoHS) Directive 2002/95/EC.

Consequently, this product also complies with other regulations that have arisen in various geographical areas, and that reference the European Union's RoHS directive.

Batteries

Batteries are regulated in many countries. Check with your reseller to find out how to recycle used batteries.

Packaging

Many countries have regulations restricting the use of certain heavy metals in product packaging. The packaging used by SMART Technologies to ship products complies with applicable packaging laws.

Covered Electronics Devices

Many U.S. states classify monitors as Covered Electronic Devices and regulate their disposal. Applicable SMART Technologies products meet the requirements of the Covered Electronic Devices regulations.

China's Electronic Information Products Regulations

China regulates products that are classified as EIP (Electronic Information Products). SMART Technologies products fall under this classification and meet the requirements for China's EIP regulations.

U.S. Consumer Product Safety Improvement Act

The United States has enacted the *Consumer Product Safety Improvement Act* which limits the lead (Pb) content in products. SMART Technologies is committed to complying with this initiative.

Appendix B

Customer Support

Online Information and Support

Visit www.smarttech.com/support to view and download user's guides, how-to and troubleshooting articles, software and more.

Training

Visit www.smarttech.com/trainingcenter for training materials and information about our training services.

Technical Support

If you experience difficulty with your SMART product, please contact your local reseller before contacting SMART Technical Support. Your local reseller can resolve most issues without delay.

NOTE

To locate your local reseller, visit www2.smarttech.com/st/en-US/Where+to+Buy.

All SMART products include online, telephone, fax and e-mail support:

Online	www.smarttech.com/contactsupport
Telephone	+1.403.228.5940 or Toll Free 1.866.518.6791 (U.S./Canada) (Monday to Friday, 5 a.m. – 6 p.m. Mountain Time)
Fax	+1.403.806.1256
E-mail	support@smarttech.com

Shipping and Repair Status

Contact SMART's Return of Merchandise Authorization (RMA) group, Option 4, +1.866.518.6791, for shipping damage, missing part and repair status issues.

General Inquiries

Address SMART Technologies
3636 Research Road NW
Calgary, AB T2L 1Y1
CANADA

Switchboard +1.403.245.0333 or
Toll Free 1.888.42.SMART (U.S./Canada)

Fax +1.403.228.2500

E-mail info@smarttech.com

Warranty

Product warranty is governed by the terms and conditions of SMART's "Limited Equipment Warranty" that shipped with the SMART product at the time of purchase.

Registration

To help us serve you, register online at www.smarttech.com/registration.

SMARTTM

Toll Free 1.866.518.6791 (U.S./Canada)
or +1.403.228.5940
www.smarttech.com